



Specification

Nominal voltage	12 Volts	
Rated capacity (C ₂₀ Hour rate at 27°C)	130 Ampere Hour	
Dimensions (±2 mm)	Length	445 mm
	Width	168 mm
	Height	247 mm
Weight ± 1.0 Kgs (approx.)	42.0 Kgs	

Characteristics *

Capacity@ 80.6°F (27°C)	20 hour rate (6.50A) upto 10.5V	130.0 Ah
	10 hour rate (12.10A) upto 10.5V	121.0 Ah
	5 hour rate (22.30A) upto 10.2V	111.50 Ah
	1 hour rate (84.42A) upto 9.6V	84.42 Ah
	15 minute rate (234.66A) upto 9.6V	58.66 Ah
Internal resistance	Fully charged battery 80.6°F (27°C)	4.54 mΩ
Capacity affected (Temperature at C ₂₀ hour rate)	104°F (40°C)	110%
	80.6°F (27°C)	100%
	32°F (0°C)	80%
	5°F (-15°C)	60%
Self discharge 80.6°F (27°C)	Capacity after 3 month storage	90%
	Capacity after 6 month storage	80%
Terminal Type	M6×25 mm bolted	
Short circuit current	2803 A	

Constant power discharge rating watts per battery @ 27° C *

ECV	DURATION										
	10 min	15 min	20 min	30 min	60 min	2 hr	3 hr	5 hr	8 hr	10 hr	20 hr
1.60	3128	2602	1965	1608	919	557	403.0	279.0	183.0	148.0	79.0
1.65	3073	2543	1945	1558	904	549	400.0	274.5	179.0	147.5	78.5
1.70	3017	2483	1924	1508	889	541	397.0	270.0	176.5	147.0	78.0
1.75	2886	2365	1888	1482	861	532	394.0	266.0	173.0	146.0	77.5
1.80	2755	2247	1852	1456	833	522	391.0	262.0	170.0	145.0	77.0

Constant current discharge rating amperes @ 27° C *

ECV	DURATION										
	10 min	15 min	20 min	30 min	60 min	2 hr	3 hr	5 hr	8 hr	10 hr	20 hr
1.60	293.59	234.66	186.25	141.30	84.42	51.20	34.99	24.09	14.94	12.64	6.96
1.65	284.70	224.60	179.40	135.70	83.40	49.10	33.90	23.20	14.60	12.50	6.80
1.70	275.72	214.52	172.64	130.00	82.28	47.05	32.88	22.30	14.29	12.33	6.61
1.75	265.31	209.68	171.05	128.71	81.25	46.43	32.83	22.22	14.21	12.10	6.50
1.80	260.00	206.35	166.67	127.45	77.75	46.10	32.66	22.03	14.13	12.04	6.47

*Note: The above data are average values and can be obtained within three charge/discharge cycles
A tolerance of ±5% is applicable for the above constant power discharge and constant current discharge values

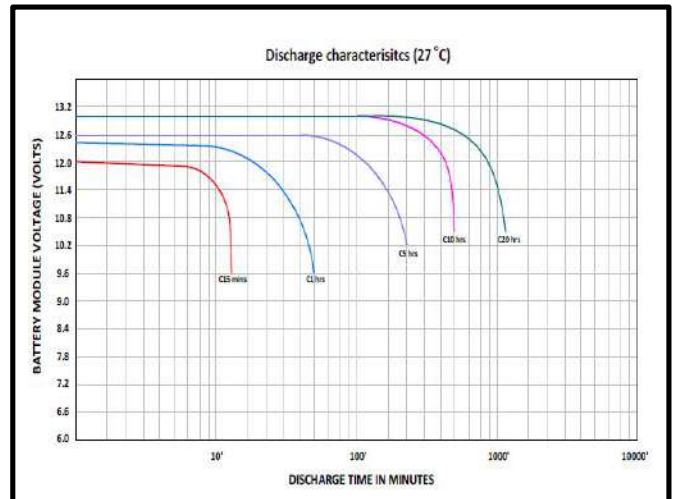
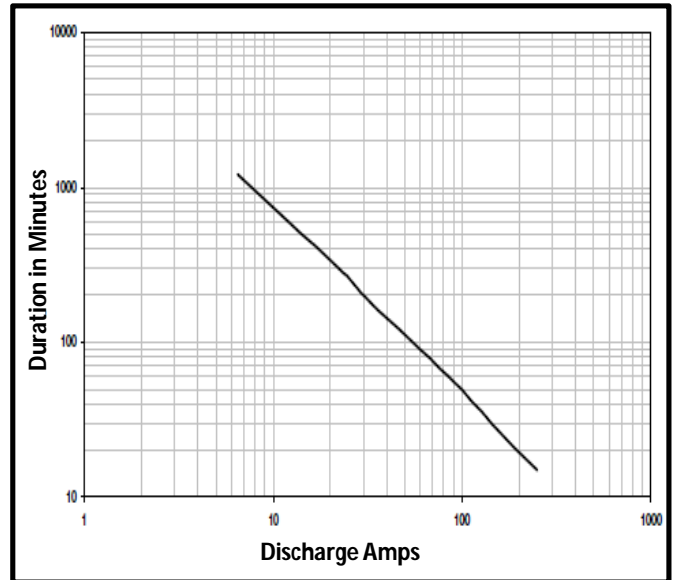
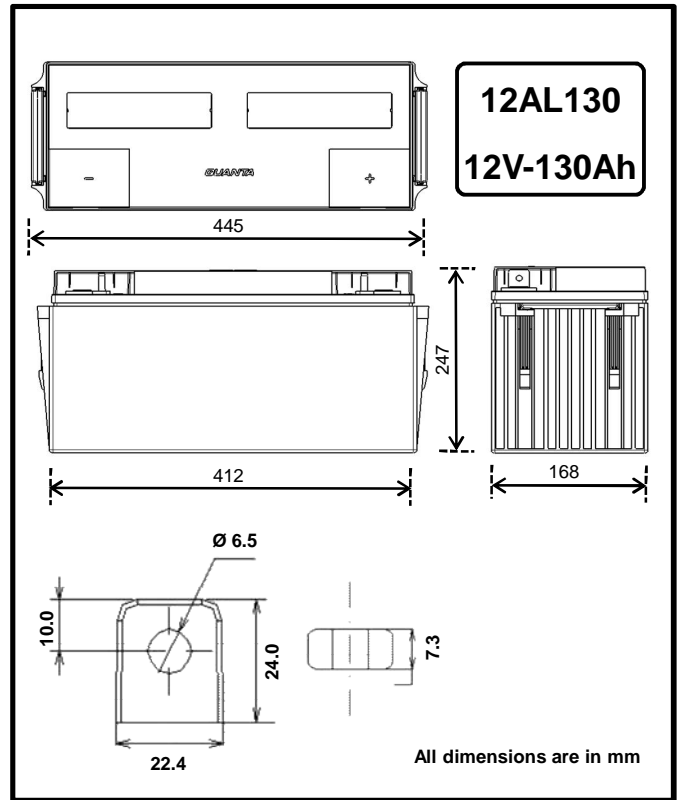

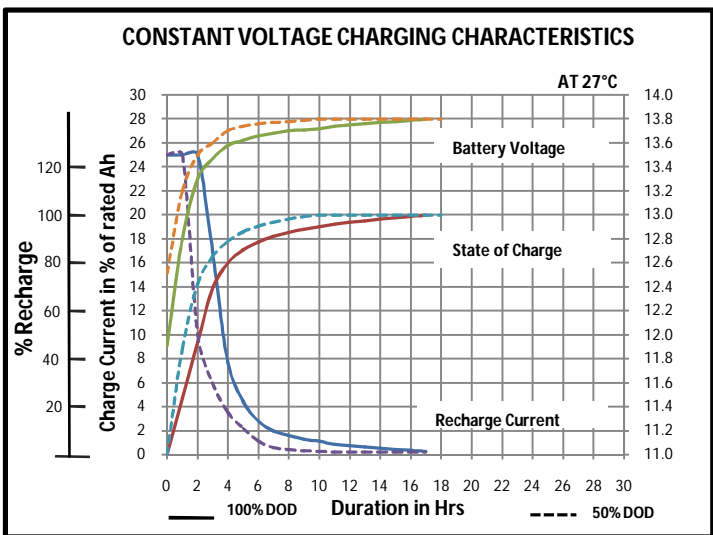
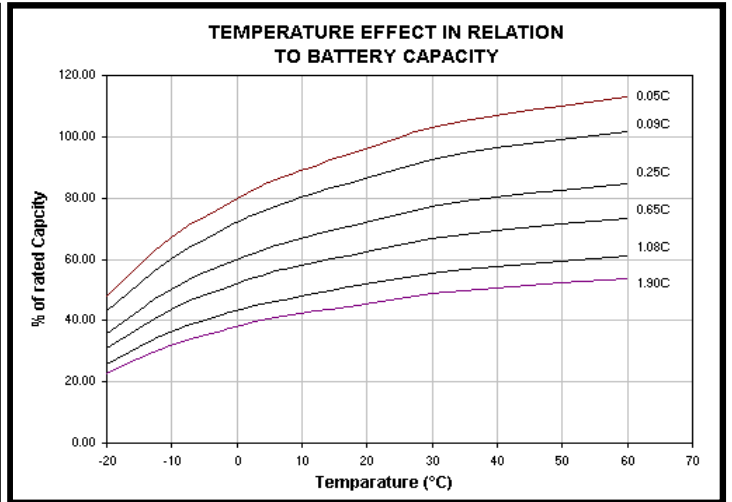
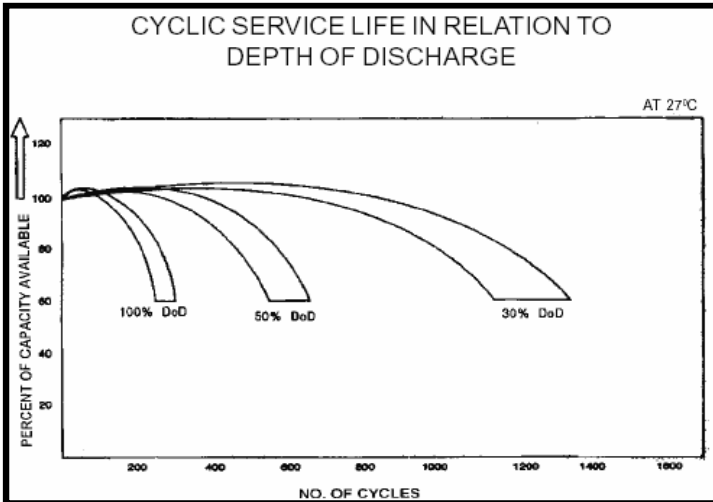
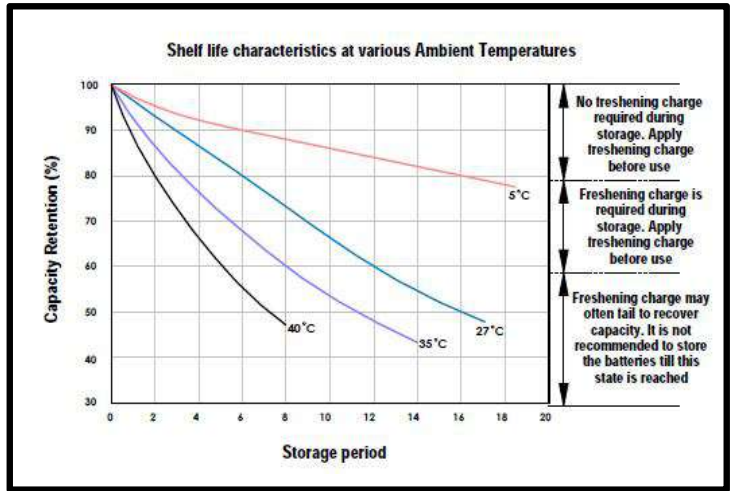
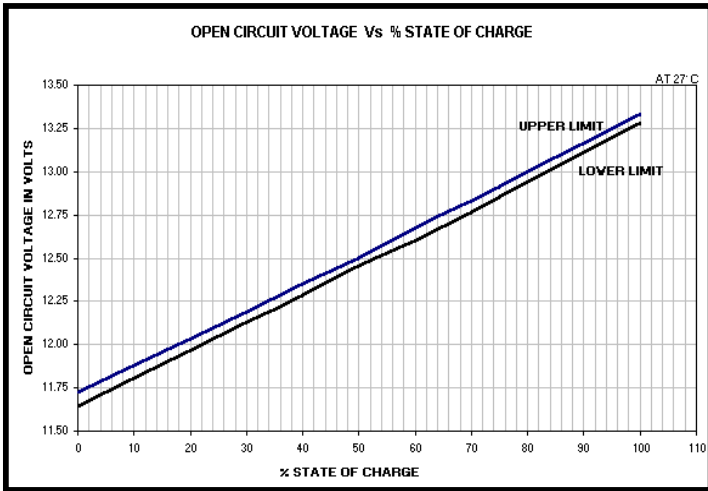

CHARGING METHODS:

Constant voltage charging at 27° C

Stand by use	: Charging voltage 13.5V/battery
Max. Charging current	: 25 % of rated Ah capacity
Cyclic use	: Charging voltage 13.8V/Battery
Max. Charging current	: 25 % of rated Ah capacity
Temperature compensation	: 18 mV/battery/°C

AMARARAJA BATTERIES LTD.

(An Amara Raja – Johnson controls company)

Regd. Office
Manufacturing facility & Central Distribution center
 Karakambadi - 517520, Tirupathi – AP , INDIA
 ☎ +91-877-2265000 ☎ +91-877-2285600
 ✉ amara Raja@amararaja.co.in

Amara Raja Batteries Ltd.
 Terminal A
 1-18/1/AMR/NR, Nanakramguda
 Gachibowli, Hyderabad - 500032
 INDIA ☎ +91-40-23139000 ☎ +91-40-23139001
 ✉ mktg@amararaja.co.in

CAUTION:

- ⚡ Avoid short circuit
- 🚫 Don't charge in a sealed container

Quality systems certified to

EN ISO 14001:2004
 ISO/TS 16949: 2009