



Specification

Nominal voltage	12 Volts	
Rated capacity (C ₂₀ Hour rate at 27°C)	65 Ampere Hour	
Dimensions (±2 mm)	Length	351 mm
	Width	167 mm
	Height	175 mm
Weight ± 1.0 Kgs (approx.)	20.0 Kgs	

Characteristics*

Capacity@ 80.6°F (27°C)	20 hour rate (3.25A) upto 10.5V	65.0 Ah
	10 hour rate (5.59A) upto 10.5V	55.90 Ah
	5 hour rate (10.29A) upto 10.2V	51.40 Ah
	1 hour rate (36.36A) upto 9.6V	36.30 Ah
	15 minute rate (101.1A) upto 9.6V	25.20Ah
Internal resistance	Fully charged battery 80.6°F (27°C)	9.40 mΩ
Capacity affected (Temperature at C ₂₀ hour rate)	104°F (40°C)	110%
	80.6°F (27°C)	100%
	32°F (0°C)	80%
	5°F (-15°C)	60%
Self discharge 80.6°F (27°C)	Capacity after 3 month storage	90%
	Capacity after 6 month storage	80%
Terminal Type	M6 x 20 mm Bolted	
Short circuit current	1382 A	

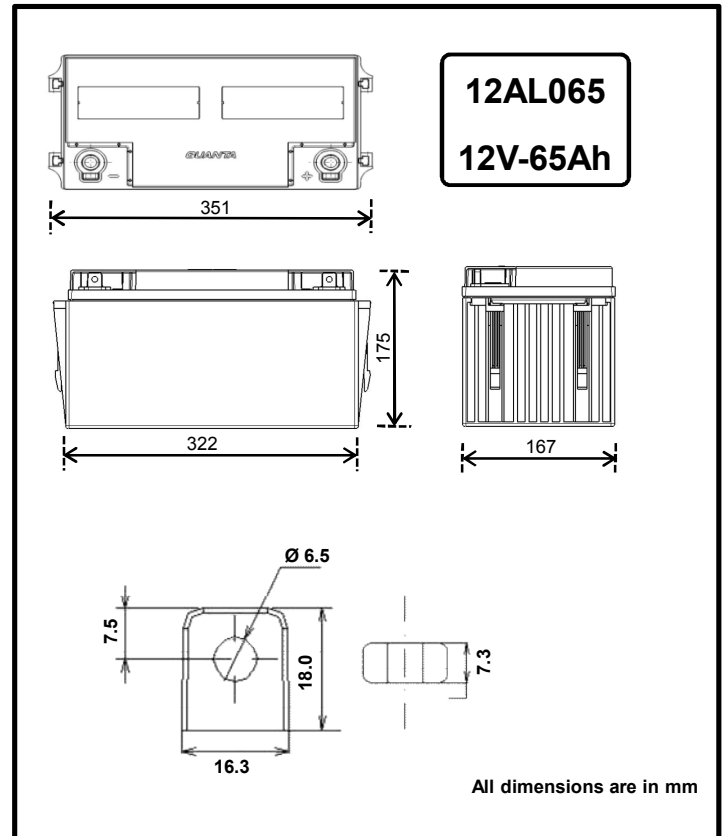

ECV	DURATION										
	10 min	15 min	20 min	30 min	60 min	2 hr	3 hr	5 hr	8 hr	10 hr	20 hr
1.60	1368	1120	898	682	412	248	172.0	118.0	77.0	67.0	31.0
1.65	1345	1101	887	671	408	245	171.0	117.0	76.5	66.5	30.5
1.70	1322	1081	876	660	403	242	170.0	116.0	76.0	66.0	30.0
1.75	1299	1041	848	640	392	239	169.0	115.0	75.0	65.0	29.5
1.80	1276	1000	820	620	380	236	168.0	114.0	74.0	64.0	29.0

ECV	DURATION										
	10 min	15 min	20 min	30 min	60 min	2 hr	3 hr	5 hr	8 hr	10 hr	20 hr
1.60	126.47	101.10	80.23	60.87	36.36	22.06	15.07	11.12	6.90	5.83	3.48
1.65	122.62	96.75	77.30	58.44	35.90	21.17	14.62	10.71	6.75	5.76	3.40
1.70	118.77	92.41	74.37	56.00	35.44	20.27	14.16	10.29	6.60	5.69	3.31
1.75	114.29	90.32	73.68	55.45	35.00	20.00	14.14	10.26	6.56	5.59	3.25
1.80	112.0	88.89	71.79	54.90	33.49	19.86	14.07	10.17	6.52	5.56	3.23

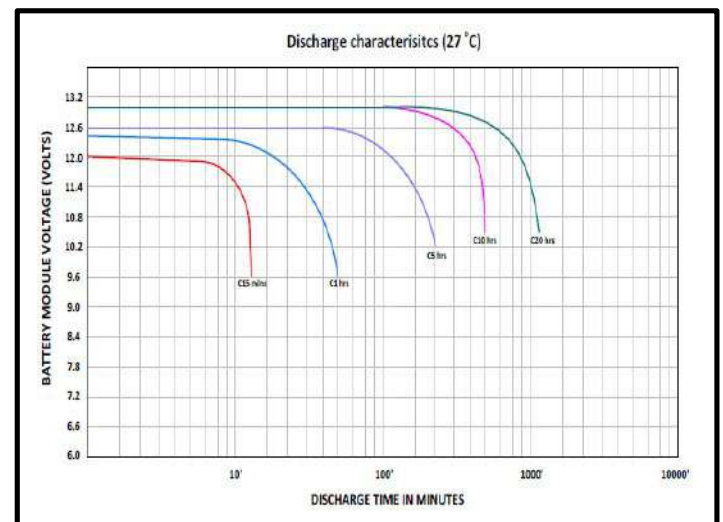

* The above data are average values and can be obtained within three charge/discharge cycles

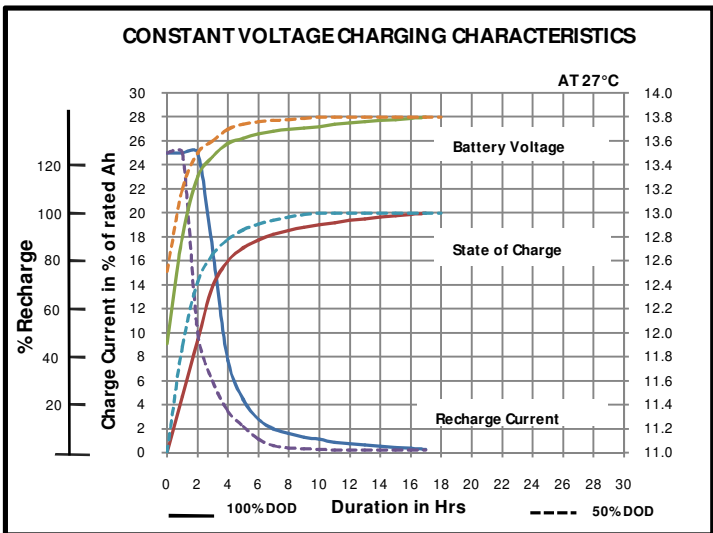
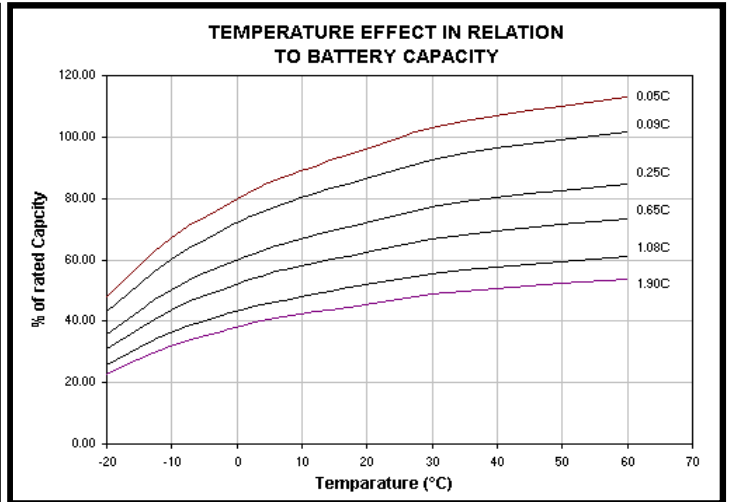
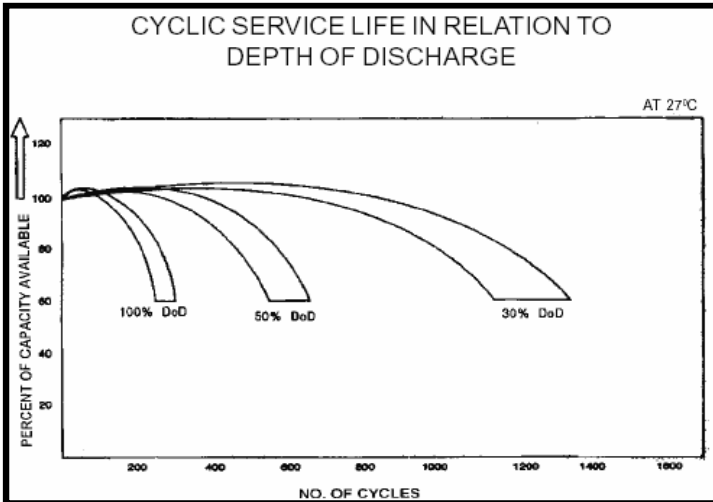
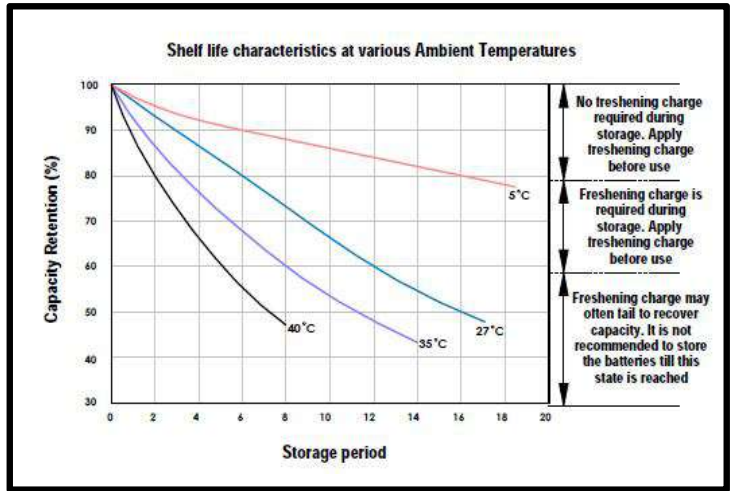
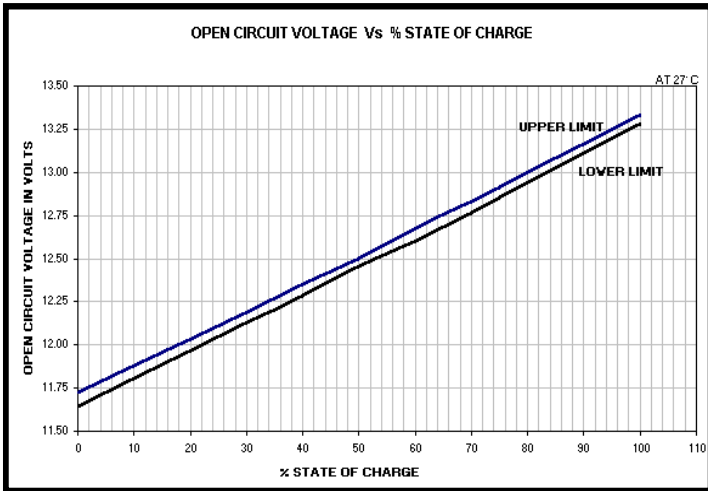

CHARGING METHODS:

Constant voltage charging at 27° C

Stand by use	: Charging voltage 13.5V/battery
Max. Charging current	: 25 % of rated Ah capacity
Cyclic use	: Charging voltage 13.8V/Battery
Max. Charging current	: 25 % of rated Ah capacity
Temperature compensation	: 18 mV/battery/°C

CAUTION:

- ⚡ Avoid short circuit
- 🚫 Don't charge in a sealed container

AMARARAJA BATTERIES LTD.

(An Amara Raja – Johnson controls company)

Regd. Office
Manufacturing facility & Central Distribution center
 Karakambadi - 517520, Tirupathi – AP , INDIA
 ☎ +91-877-2265000 📠 +91-877-2285600
 ✉ amararaja@amararaja.co.in

Amara Raja Batteries Ltd.
 Terminal A
 1-18/1/AMR/NR, Nanakramguda
 Gachibowli, Hyderabad - 500032
 INDIA ☎ +91-40-23139000 📠 +91-40-23139001
 ✉ mktg@amararaja.co.in

Quality systems certified to

EN ISO 14001:2004
 ISO/TS 16949: 2009